

These pages are designed to reinforce your Pre-K Concept Book Beginning Sounds Lessons. Use the following skill development pages at your beginning sound center to review the skills of identifying beginning sounds, circling matching pictures that begin with the same sound, crossing out pictures that do not begin with the same sound, coloring within the lines, and name writing. Send these pages home each day so parents can review the skills being taught.

Magic Penny Reading Pre-K Concept Book Skill Development for Beginning Sounds

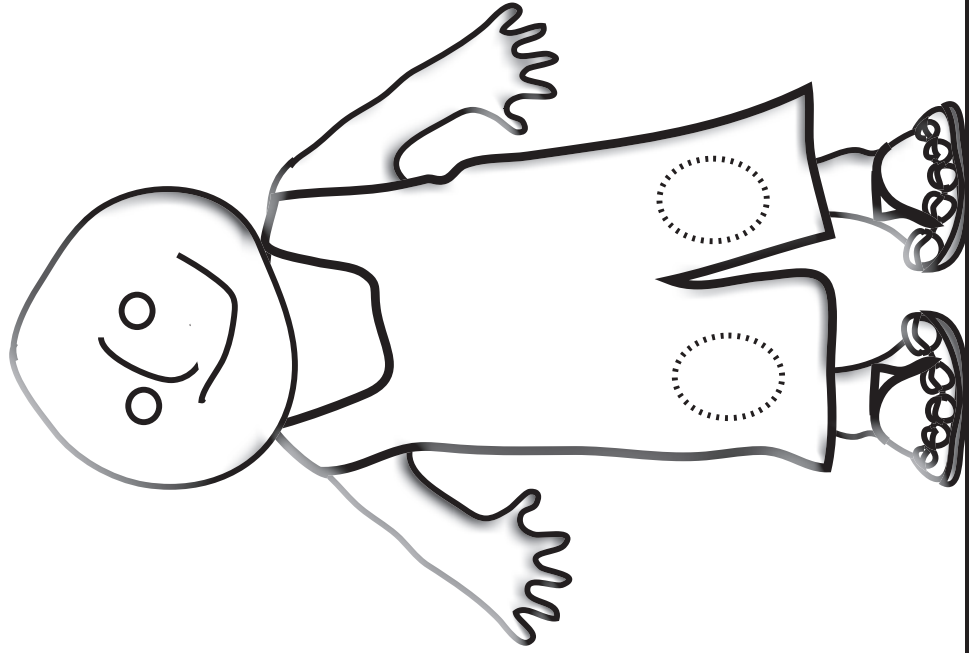

My Beginning Sound Book

©2008 Magic Penny Reading ALL RIGHTS RESERVED

Name _____



Directions:

1. Draw a circle around the picture that begins with the same sound as the picture on the top.
2. Draw an X over the picture that does not begin with the same sound.

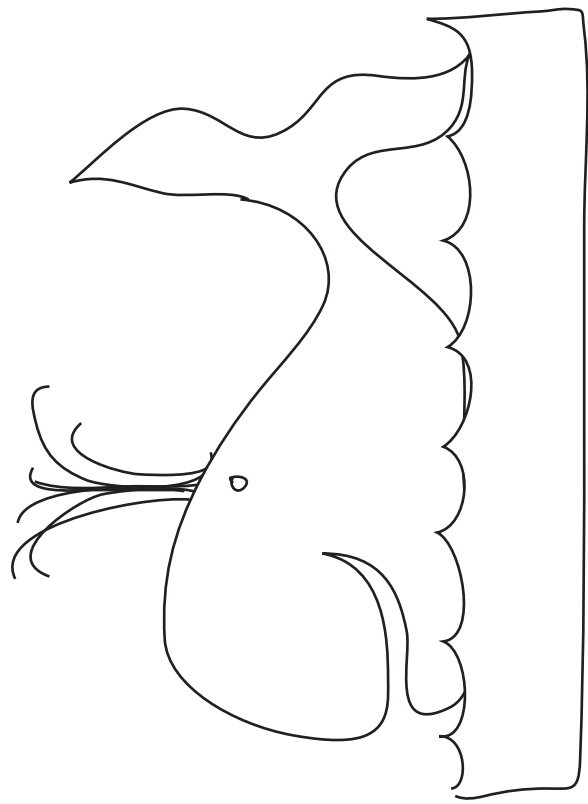
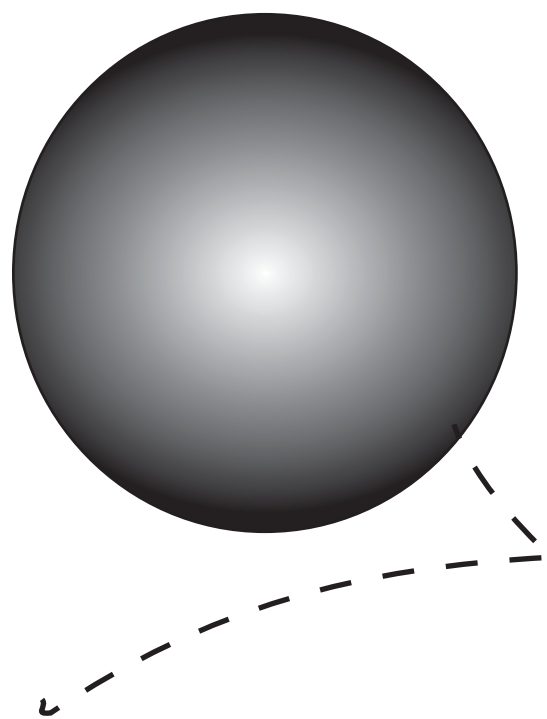
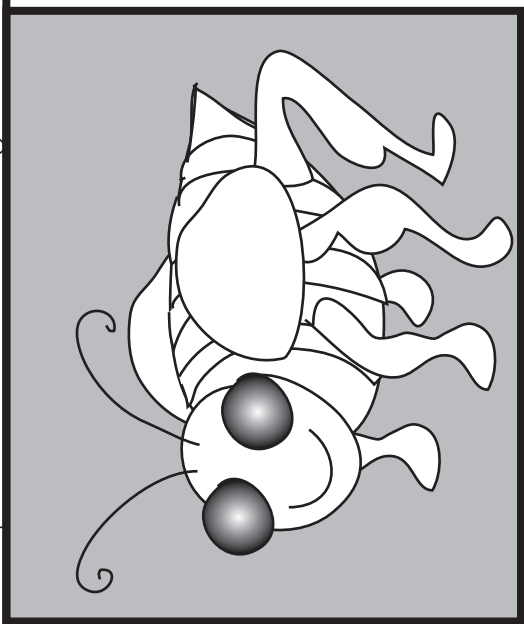

Name _____



Directions:

1. Draw a circle around the picture that begins with the same sound as the picture on the top.
2. Draw an X over the picture that does not begin with the same sound.

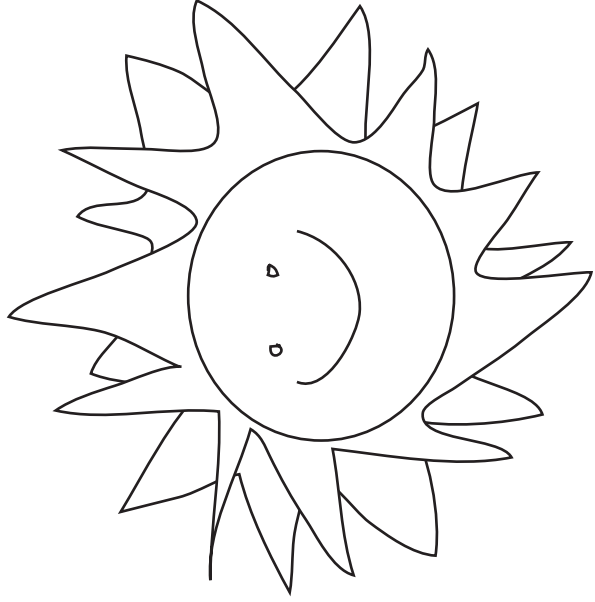
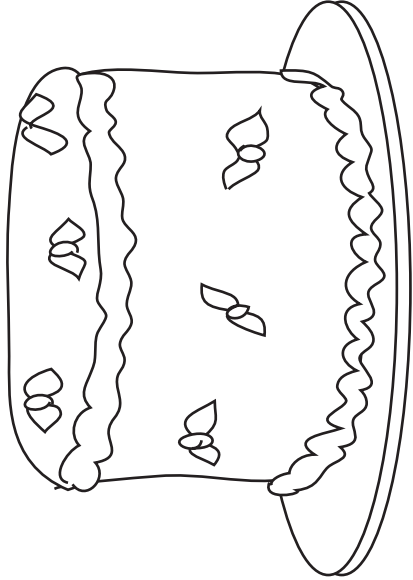
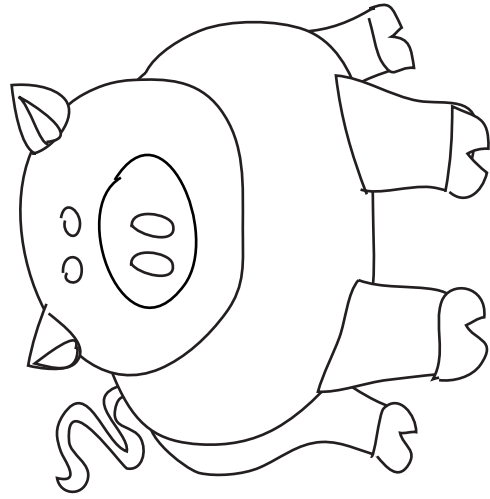
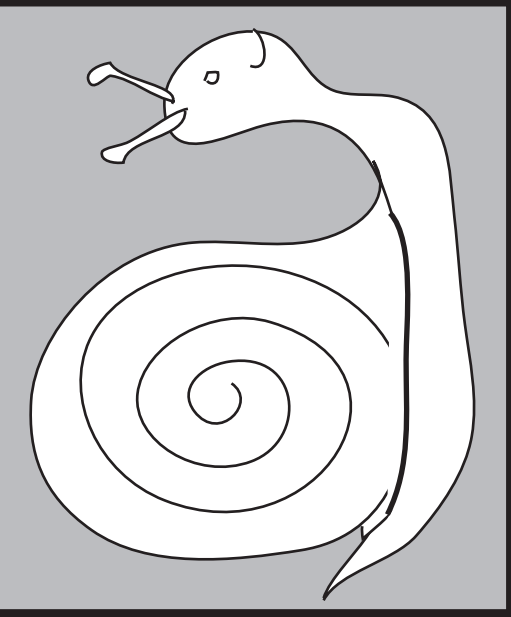

Name _____



Directions:

1. Draw a circle around the picture that begins with the same sound as the picture in the box.
2. Draw an X over the picture that does not begin with the same sound.

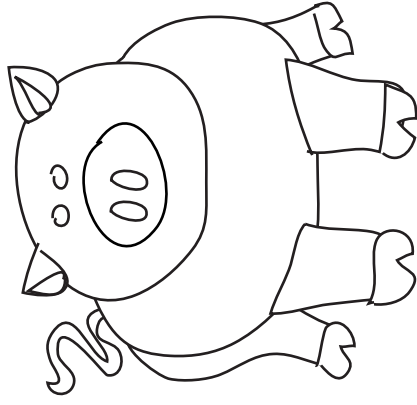
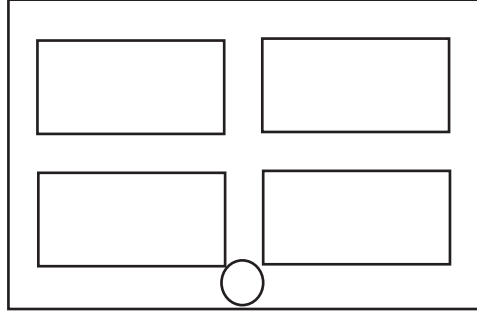
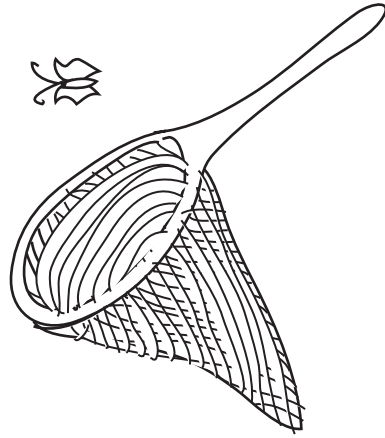
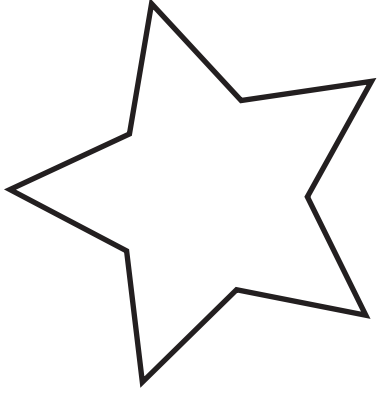
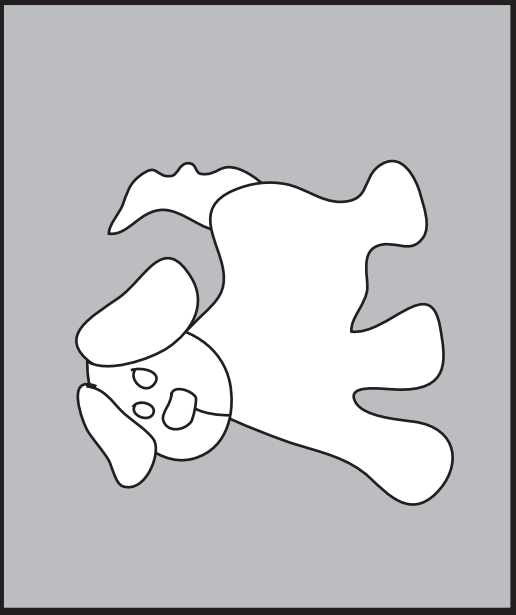
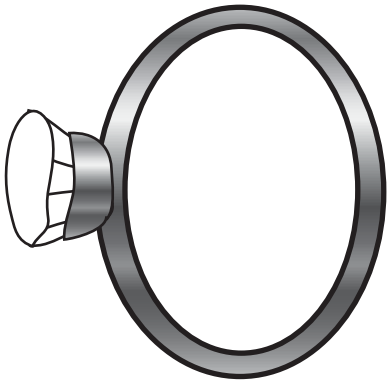

Name _____



Directions:

1. Draw a circle around the picture that begins with the same sound as the picture in the box.
2. Draw an X over the picture that does not begin with the same sound.

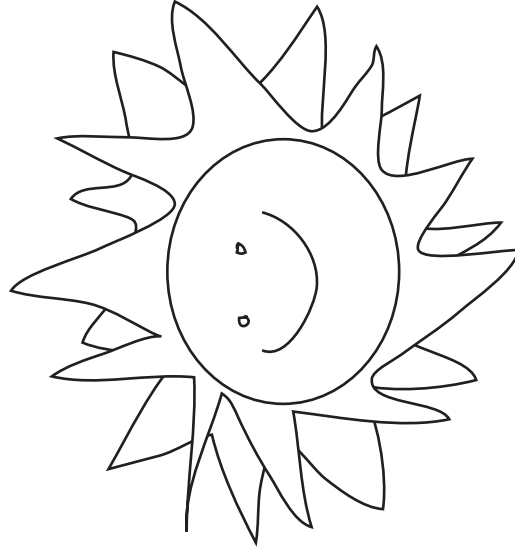
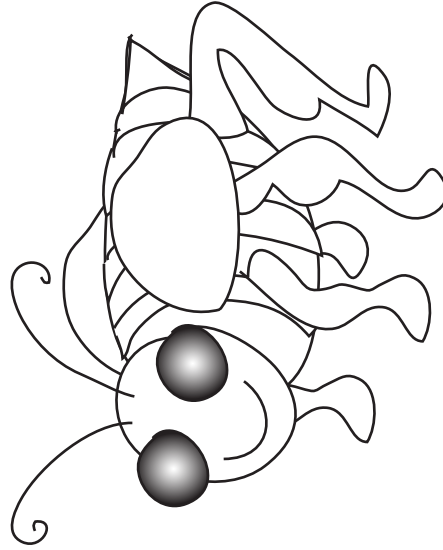
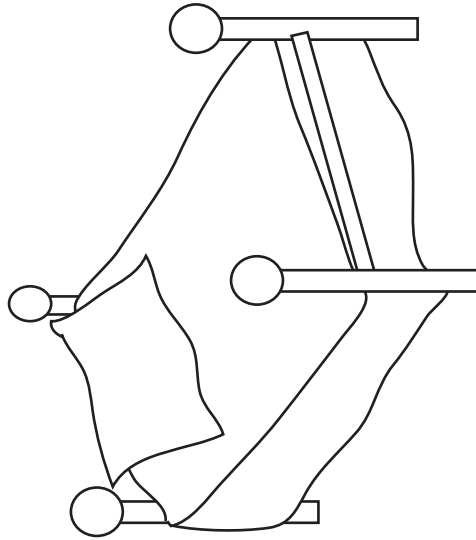
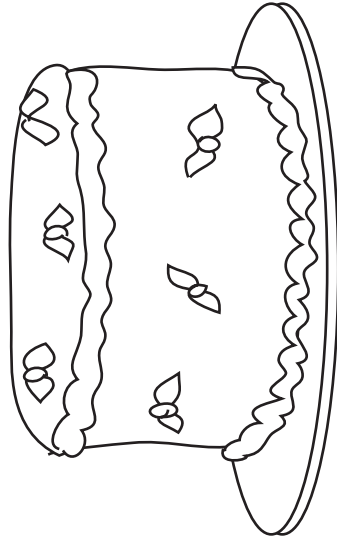
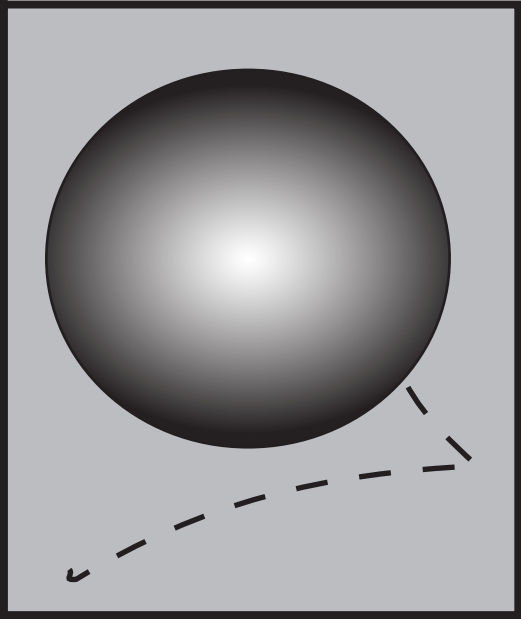
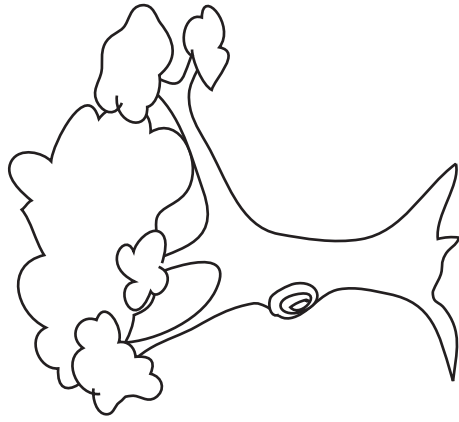

Name _____



Directions:

1. Draw a circle around the picture that begins with the same sound as the picture in the box.
2. Draw an X over the picture that does not begin with the same sound.

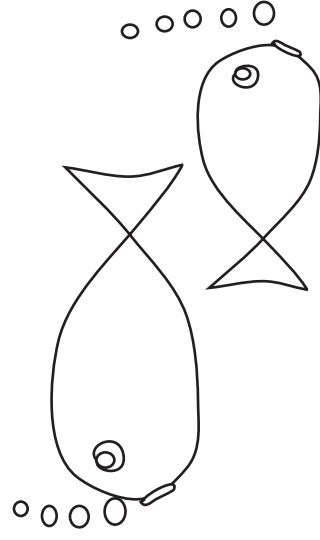
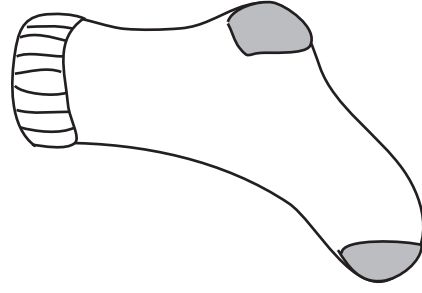
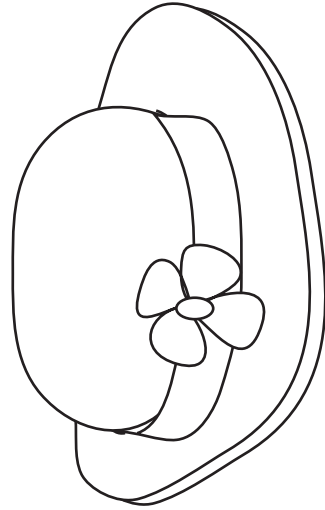
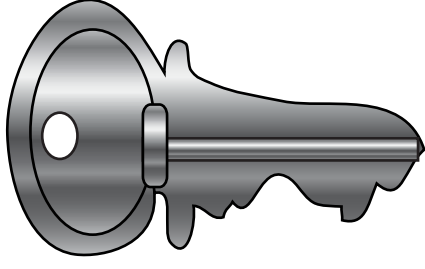
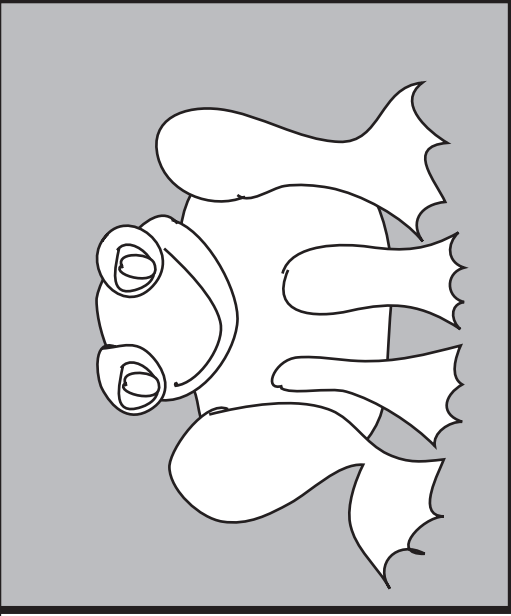

Name _____



Directions:

1. Draw a circle around the picture that begins with the same sound as the picture in the box.
2. Draw an X over the picture that does not begin with the same sound.

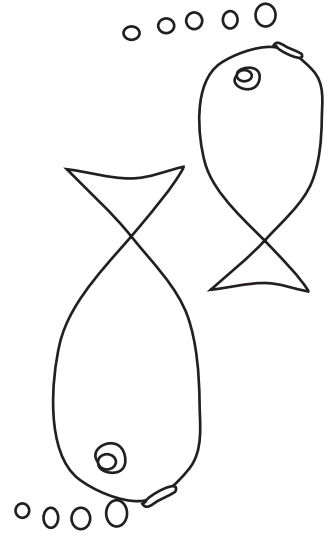
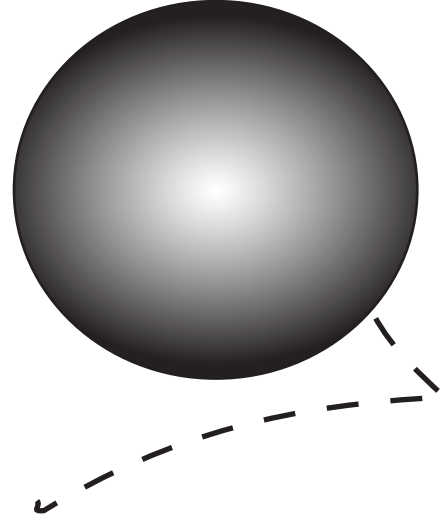
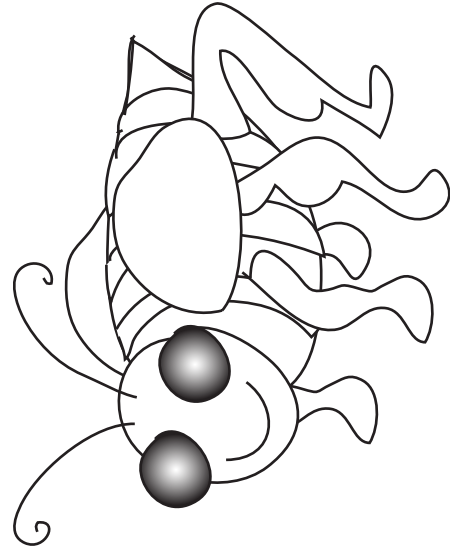
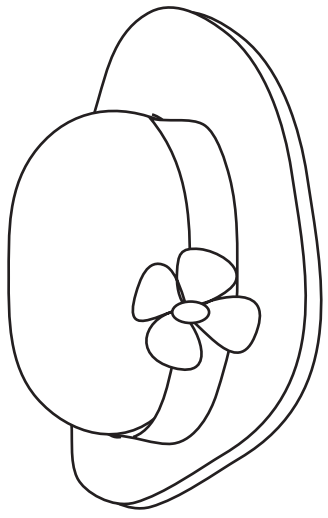
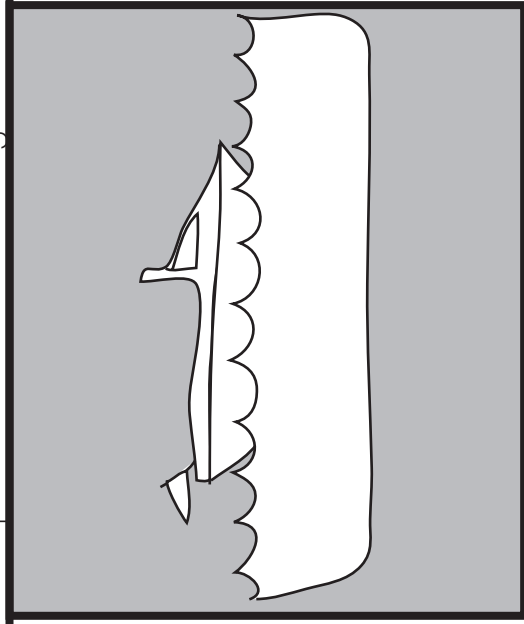
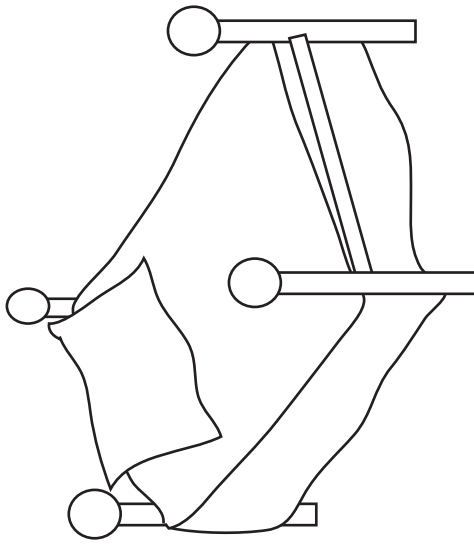

Name _____



Directions:

1. Draw a circle around the picture that begins with the same sound as the picture in the box.
2. Draw an X over the picture that does not begin with the same sound.

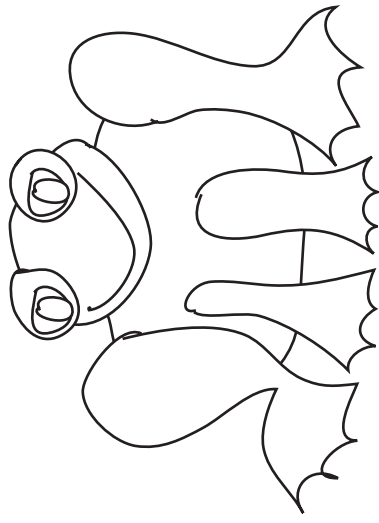
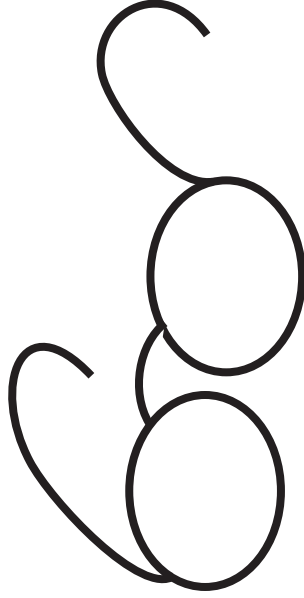
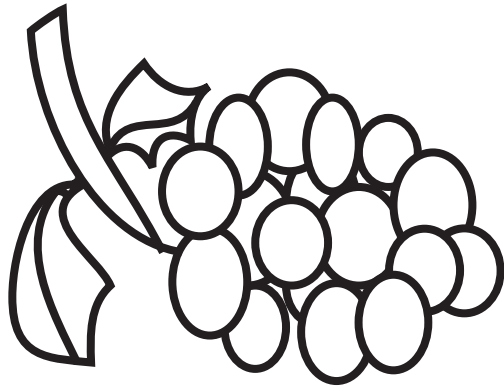
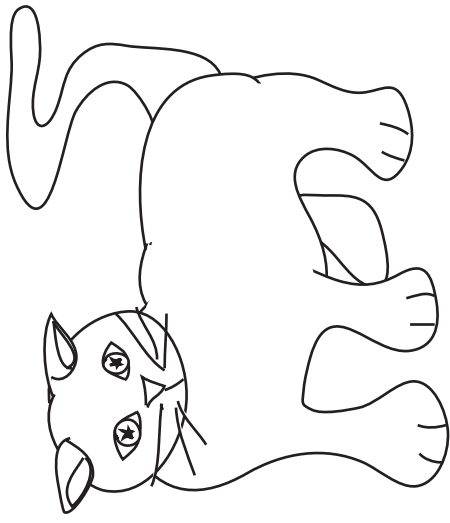
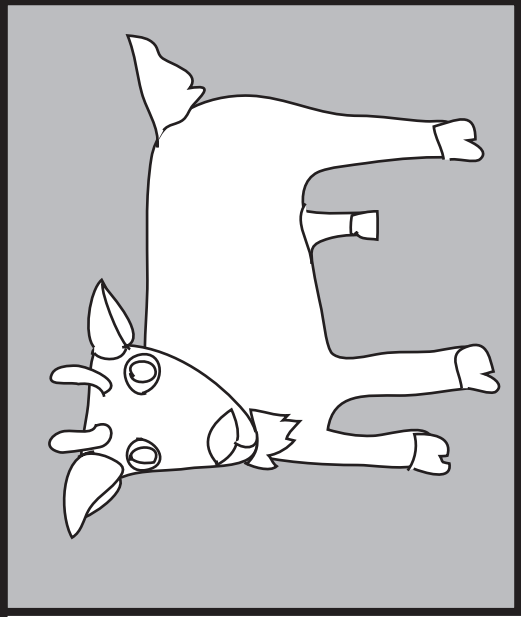
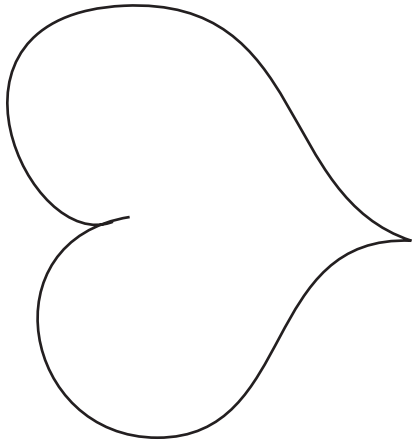

Name _____



Directions:

1. Draw a circle around the picture that begins with the same sound as the picture in the box.
2. Draw an X over the picture that does not begin with the same sound.

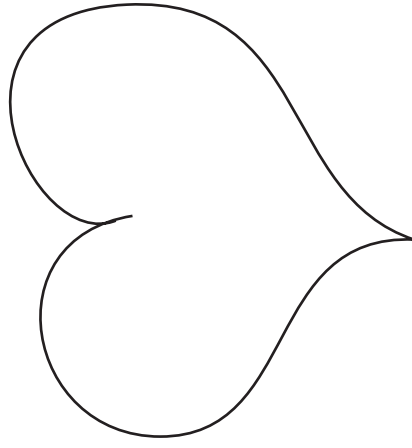
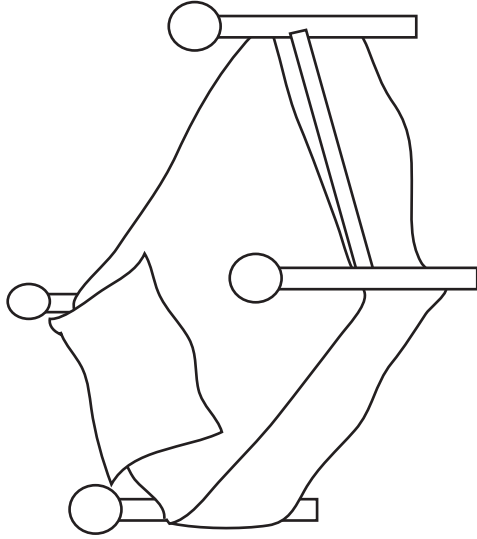
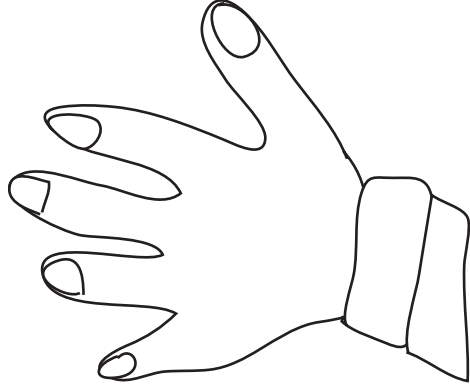
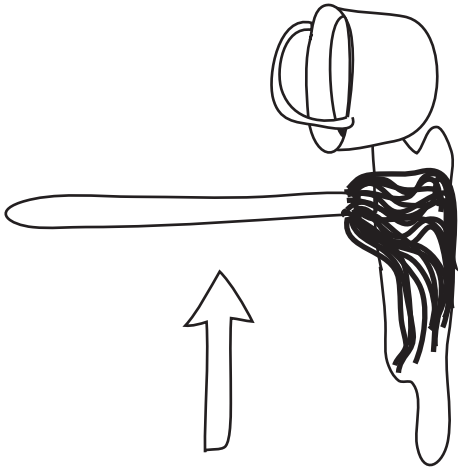
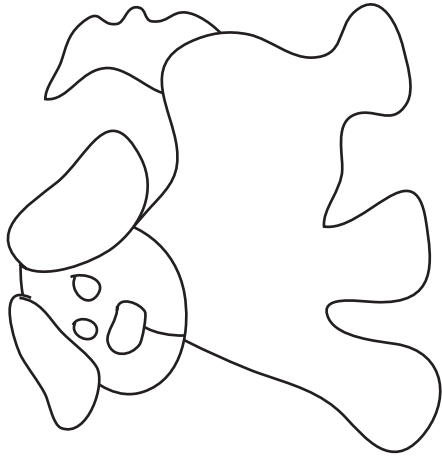
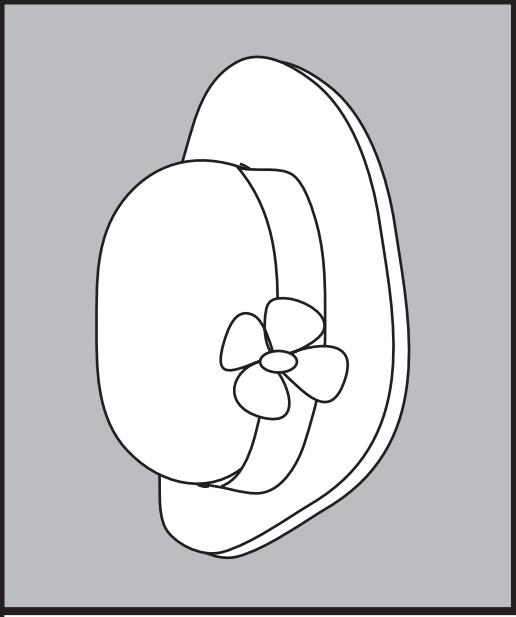

Name _____



Directions:

1. Draw a circle around the picture that begins with the same sound as the picture in the box.
2. Draw an X over the picture that does not begin with the same sound.

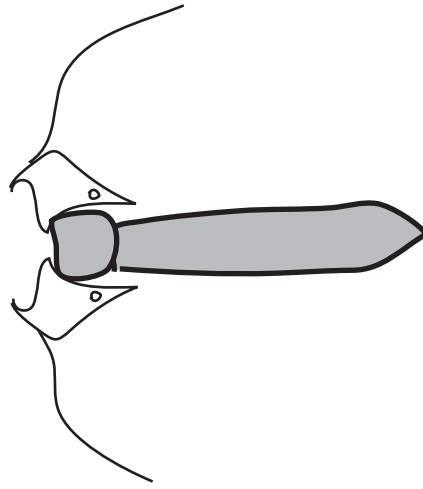
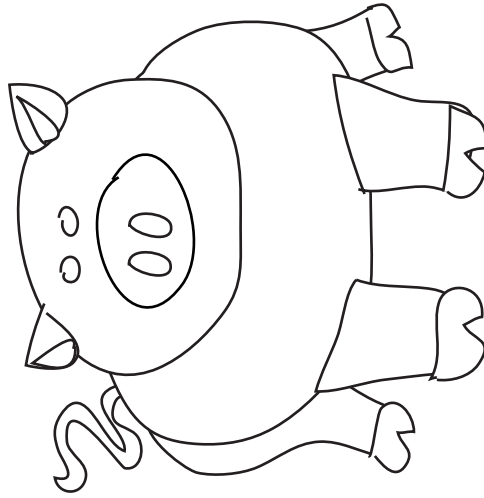
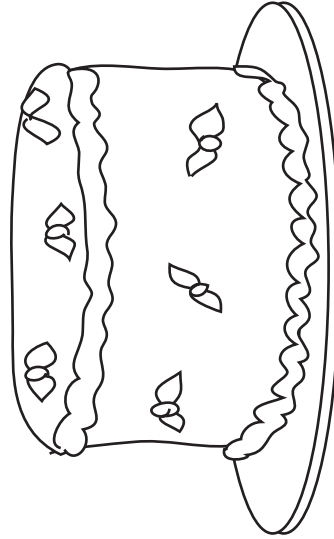
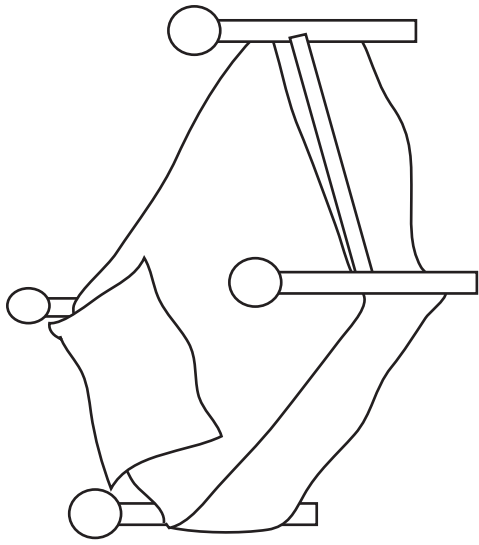
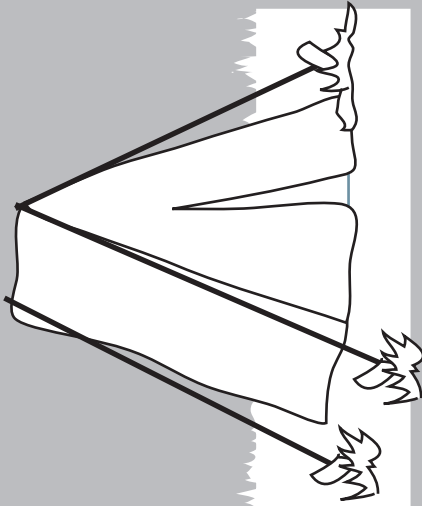
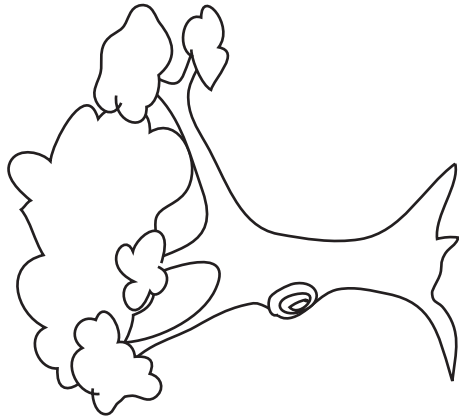

Name _____



Directions:

1. Draw a circle around the picture that begins with the same sound as the picture in the box.
2. Draw an X over the picture that does not begin with the same sound.

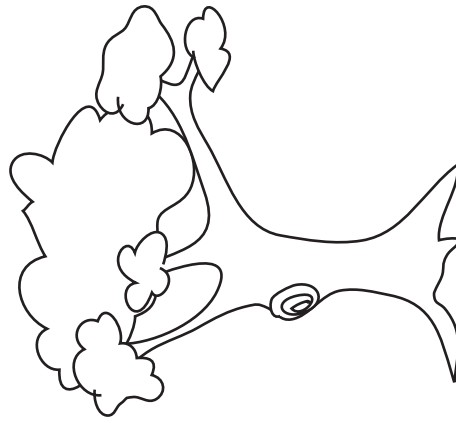
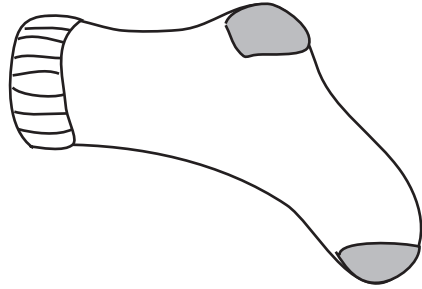
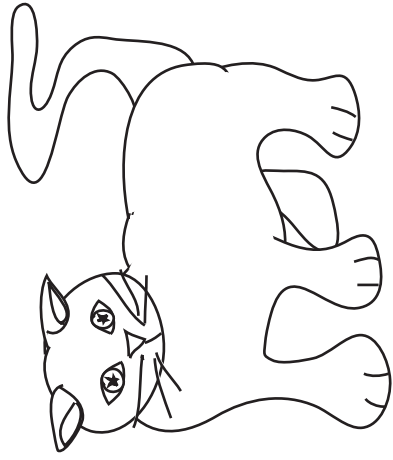
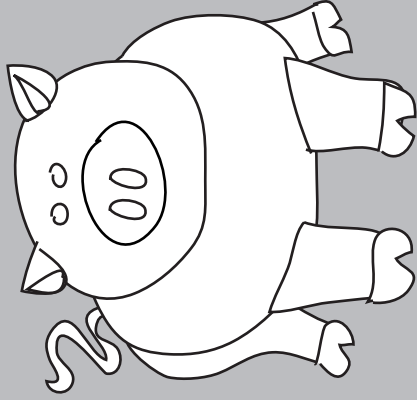
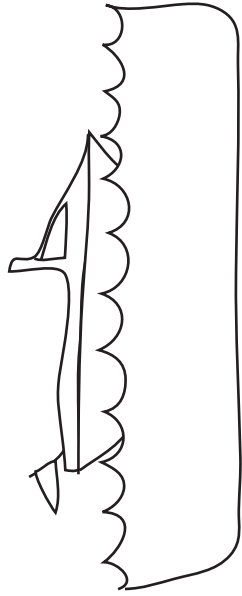

Name _____



Directions:

1. Draw a circle around the picture that begins with the same sound as the picture in the box.
2. Draw an X over the picture that does not begin with the same sound.

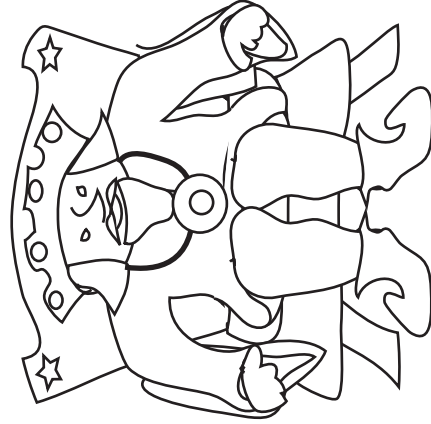
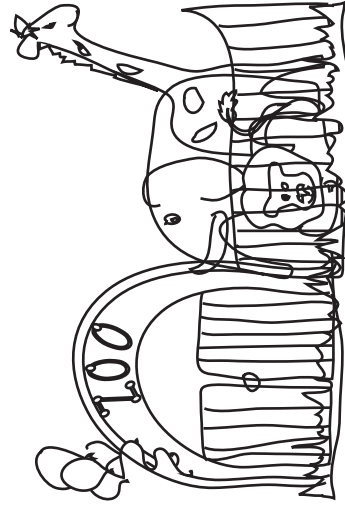
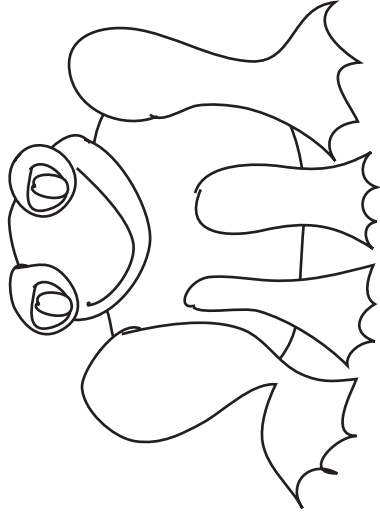
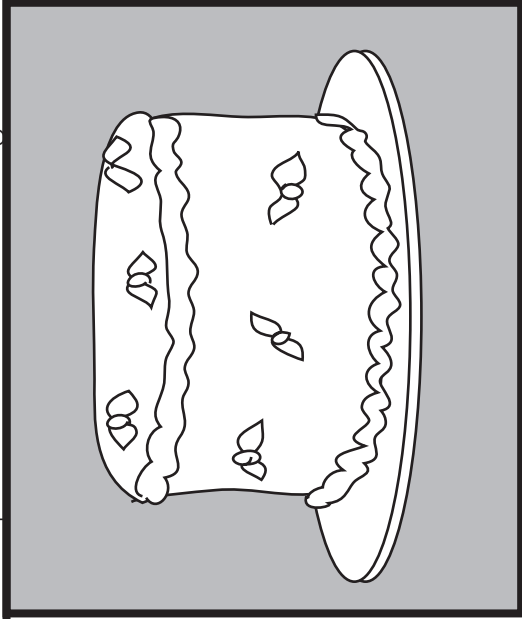
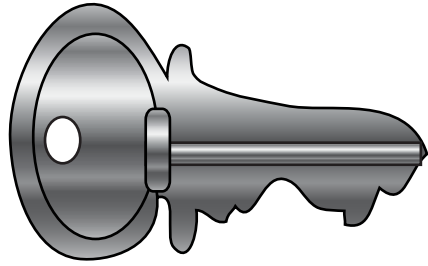

Name _____



Directions:

1. Draw a circle around the picture that begins with the same sound as the picture in the box.
2. Draw an X over the picture that does not begin with the same sound.

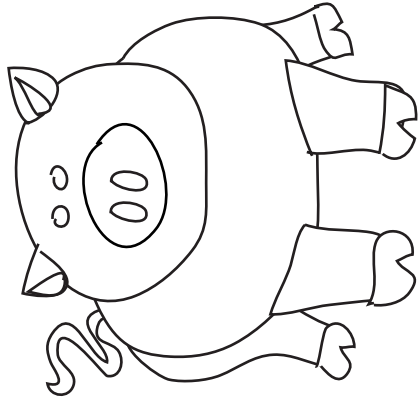
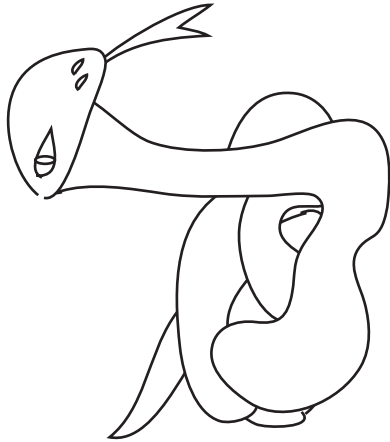
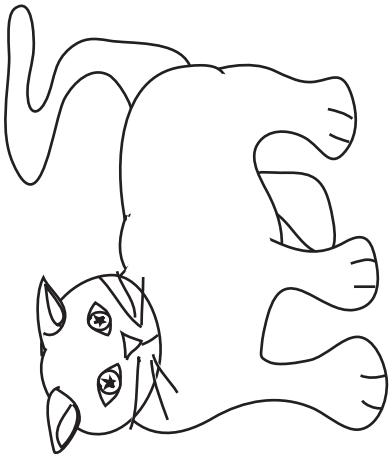
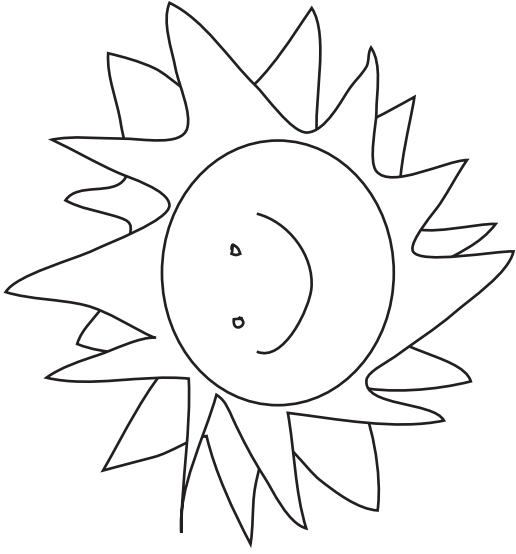
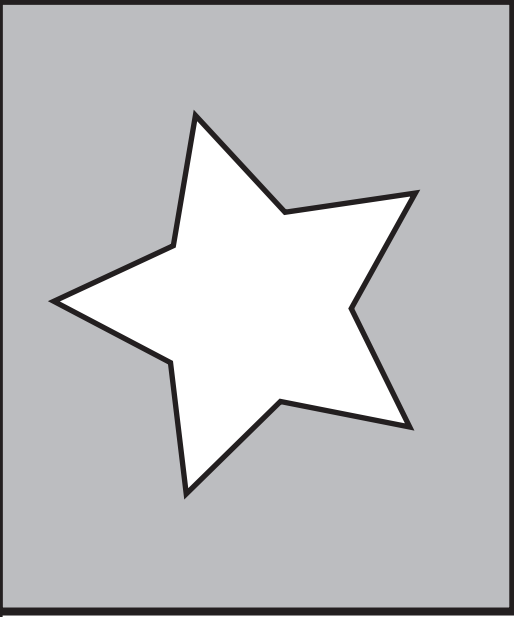

Name _____



Directions:

1. Draw a circle around the picture that begins with the same sound as the picture in the box.
2. Draw an X over the picture that does not begin with the same sound.

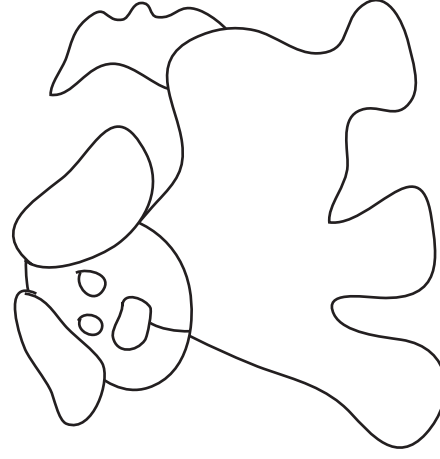
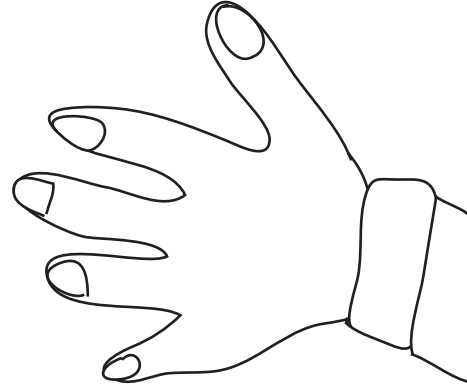
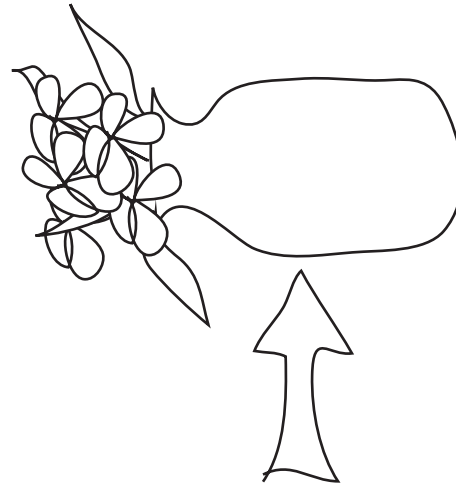
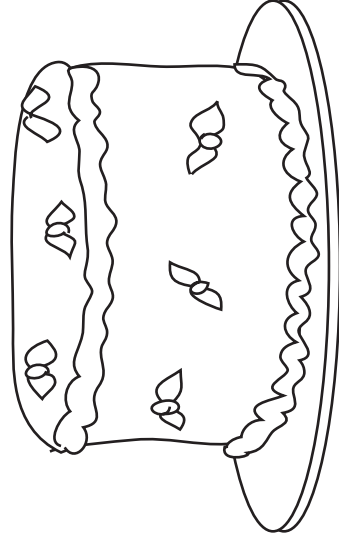
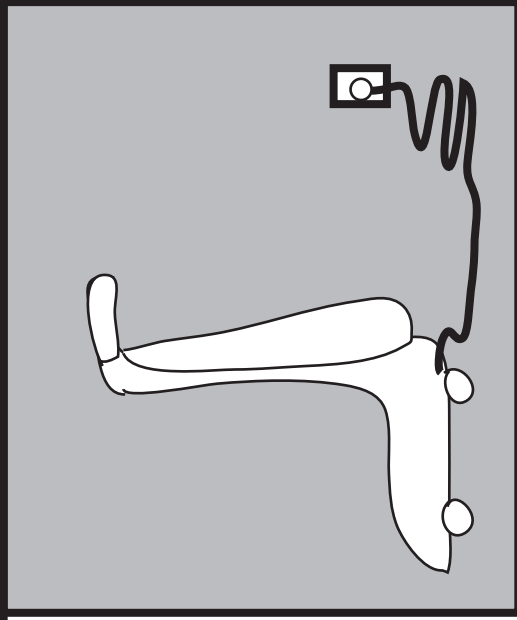

Name _____



Directions:

1. Draw a circle around the picture that begins with the same sound as the picture in the box.
2. Draw an X over the picture that does not begin with the same sound.

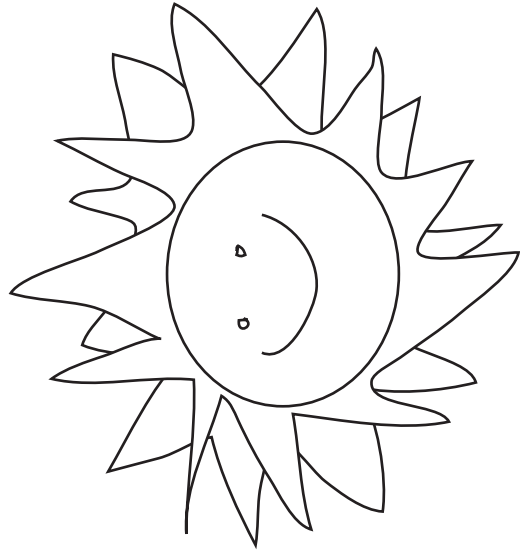
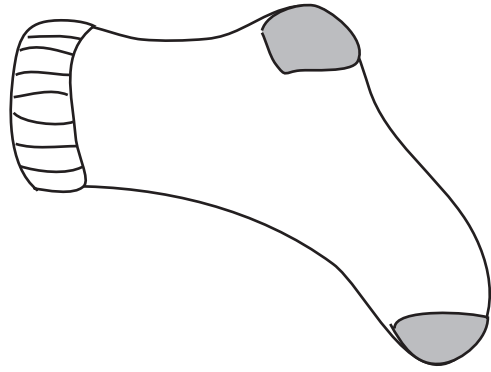
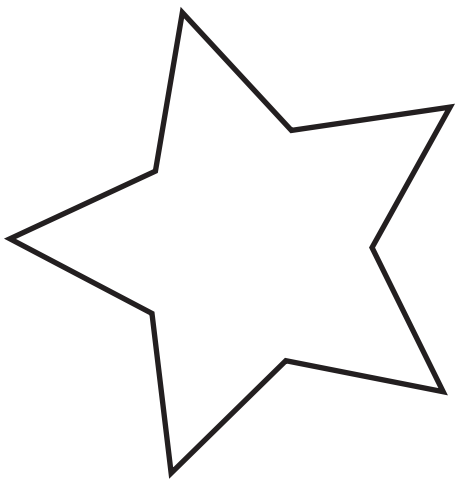
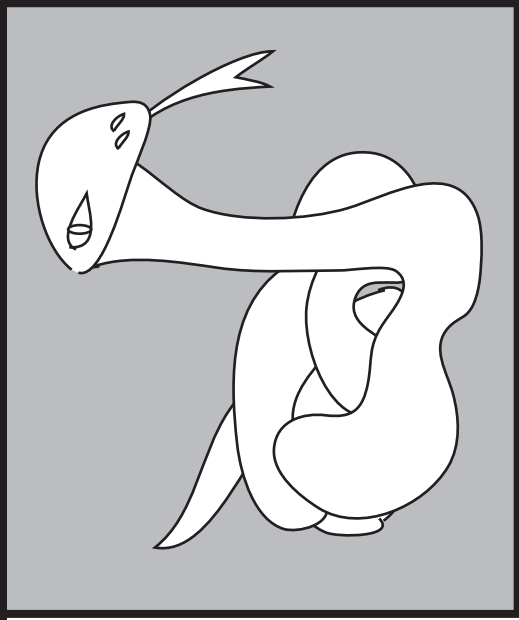
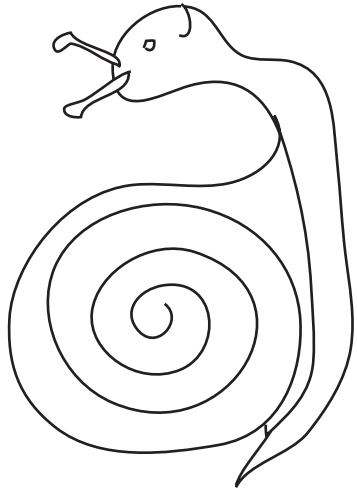

Name _____



Directions:

1. Draw a circle around the picture that begins with the same sound as the picture in the box.
2. Draw an X over the picture that does not begin with the same sound.

10

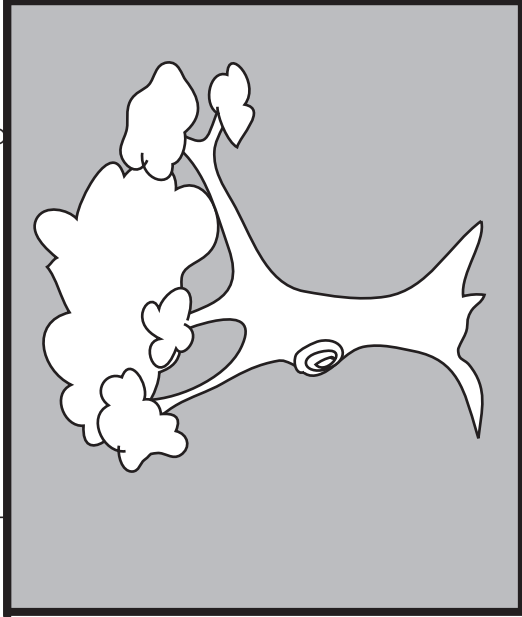

2

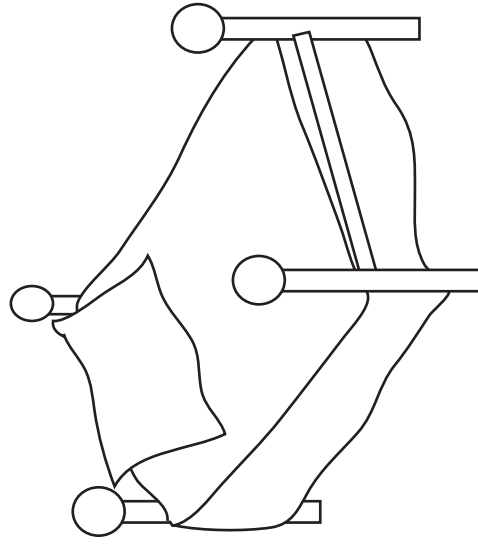
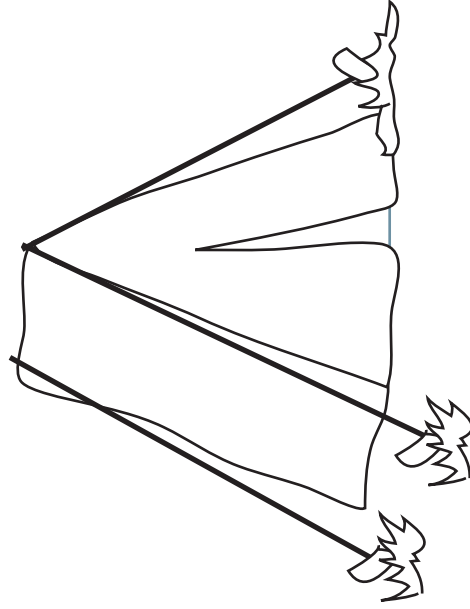
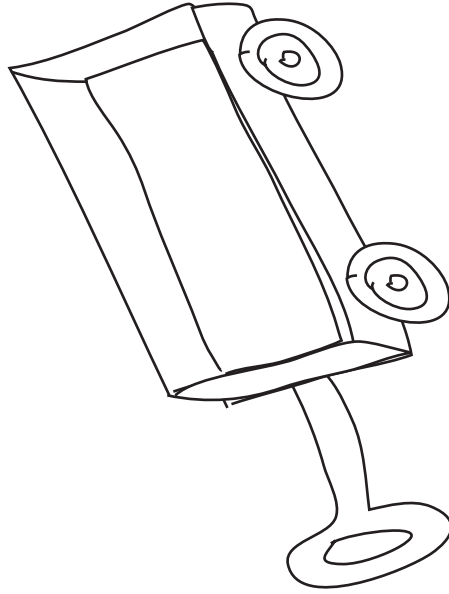

Name _____



Directions:

1. Draw a circle around the picture that begins with the same sound as the picture on the left.
2. Draw an X over the picture that does not begin with the same sound.

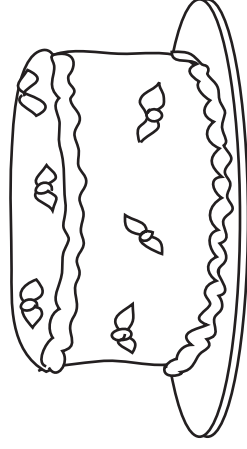
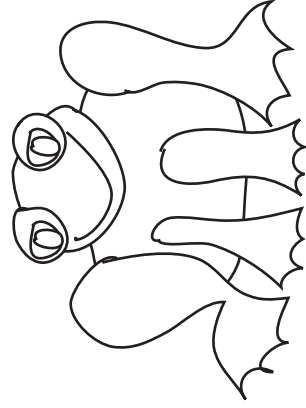
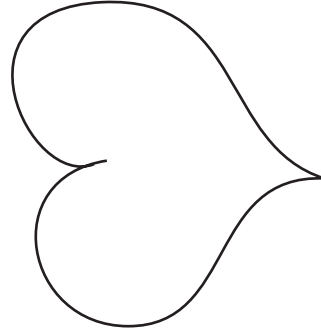
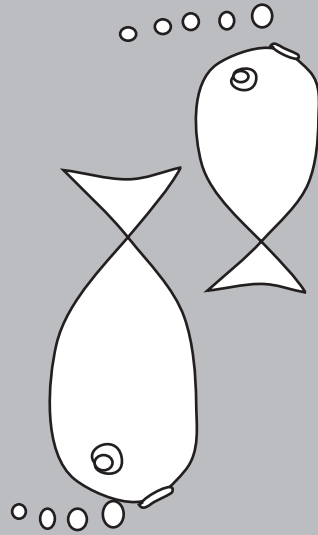
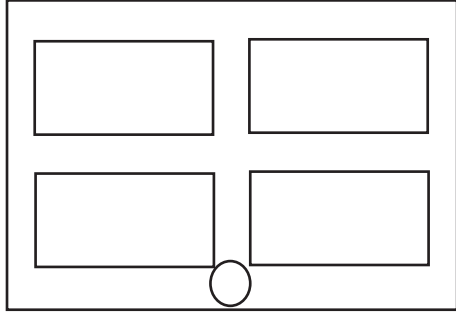
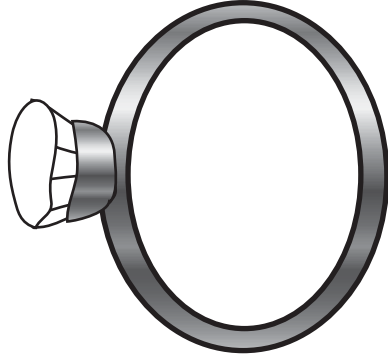
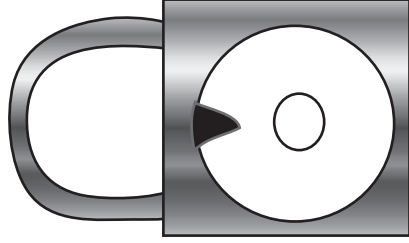
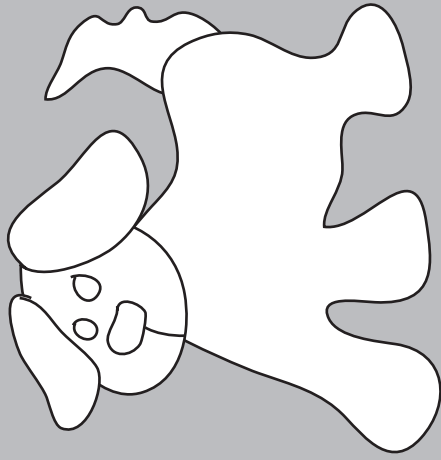

Name _____



Directions:

1. Draw a circle around the picture that begins with the same sound as the picture on the left.
2. Draw an X over the picture that does not begin with the same sound.

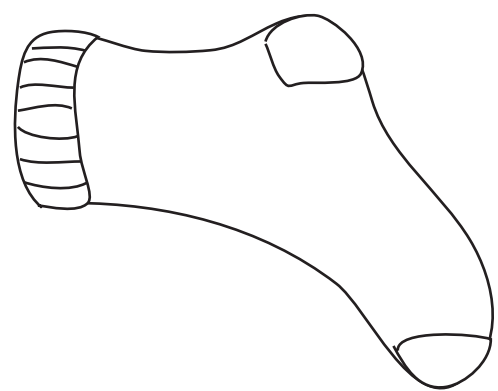
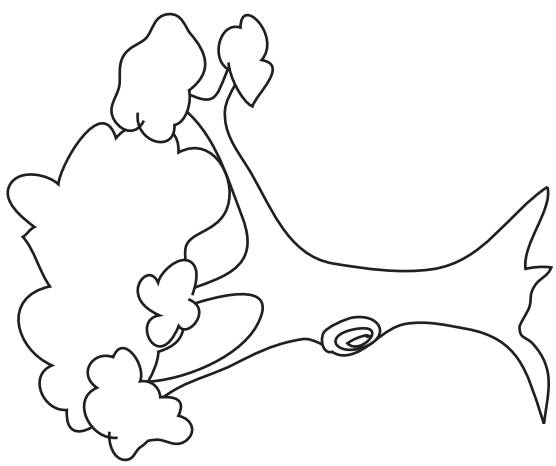
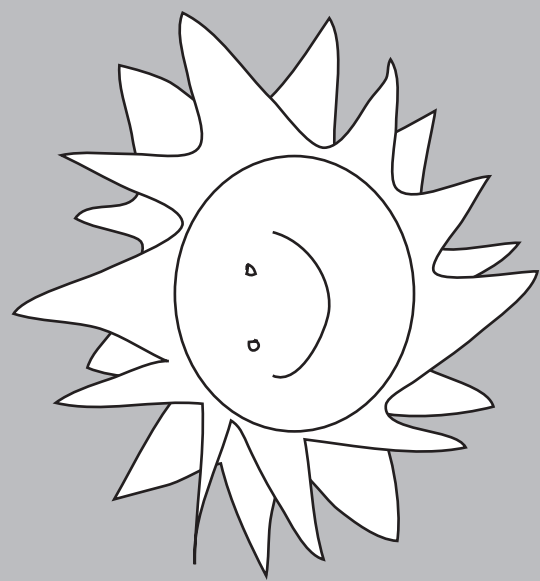
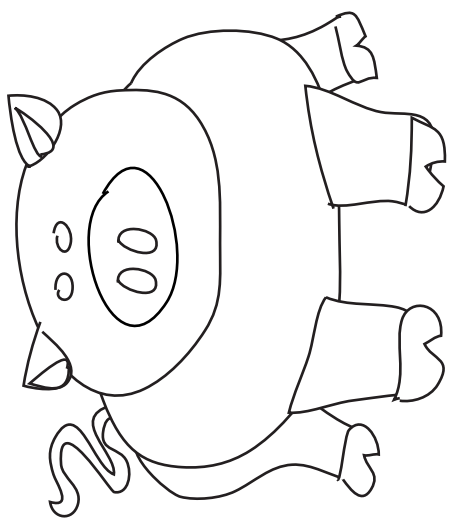
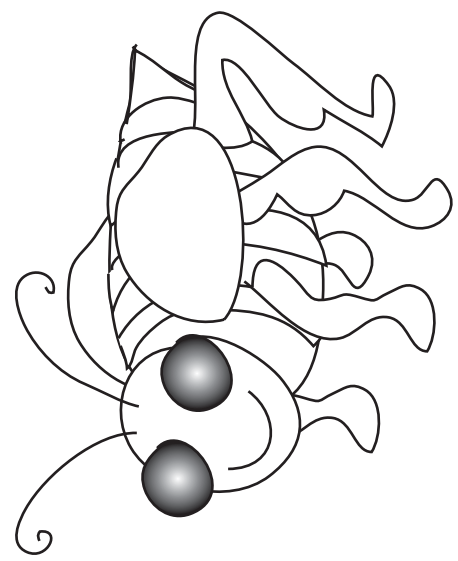
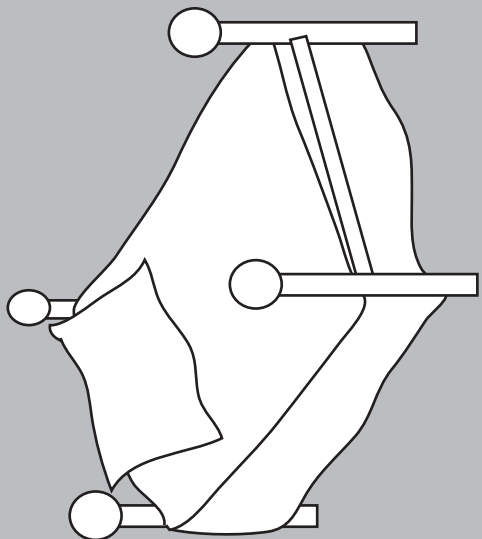

Name _____



Directions:

1. Draw a circle around the picture that begins with the same sound as the picture on the left.
2. Draw an X over the picture that does not begin with the same sound.

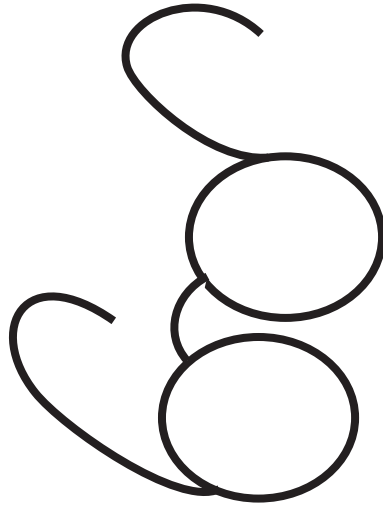
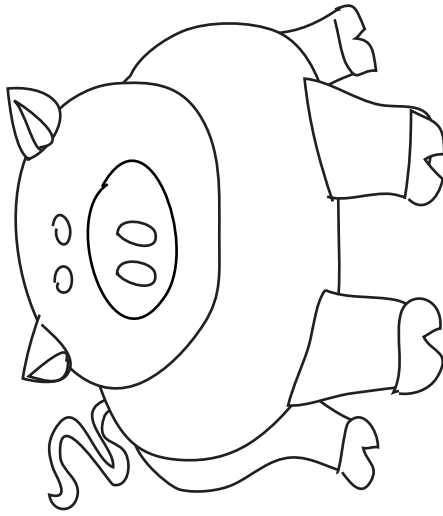
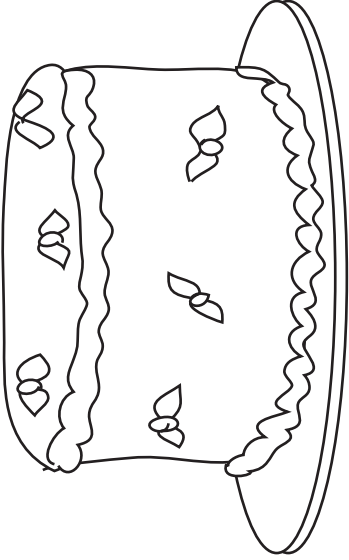
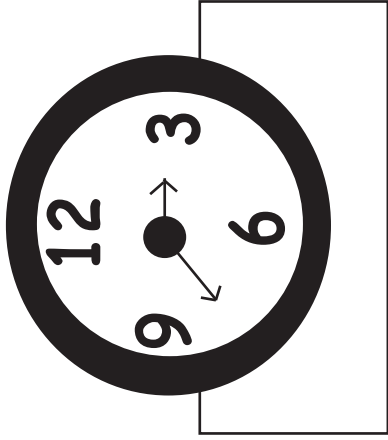
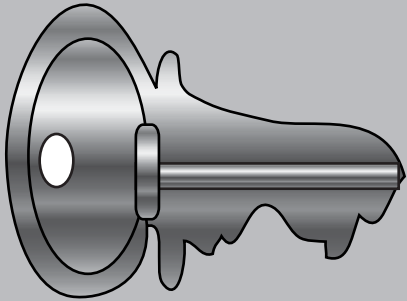

Name _____



Directions:

1. Draw a circle around all of the pictures that begin with the same sound as the picture on the left.
2. Draw an X over the pictures that do not begin with the same sound.

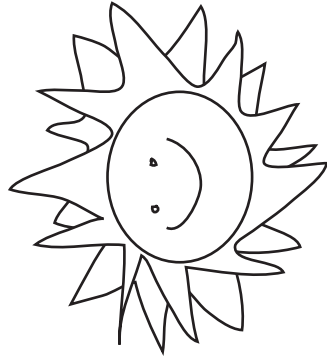
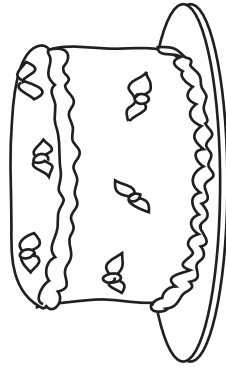
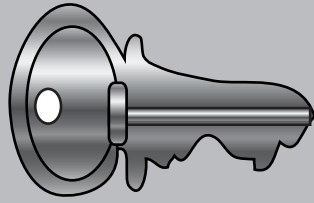
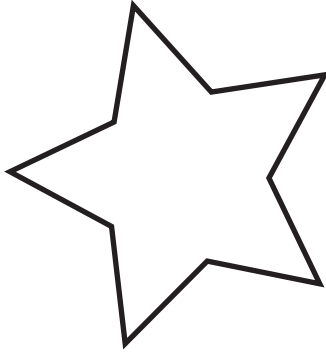
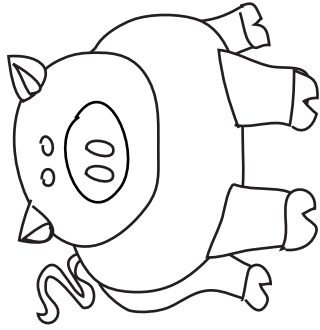
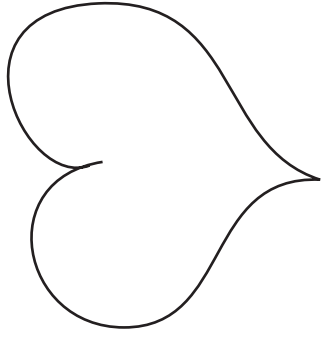
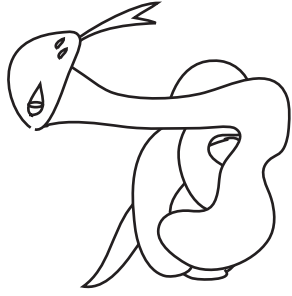
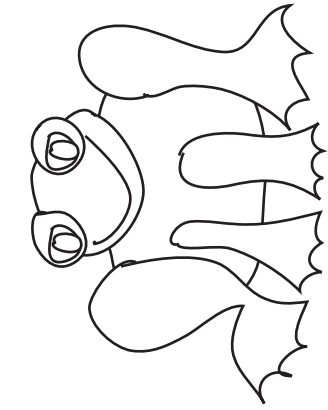
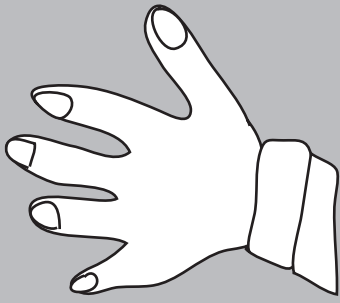

Name _____



Directions:

1. Draw a circle around all of the pictures that begin with the same sound as the picture on the left.
2. Draw an X over the pictures that do not begin with the same sound.

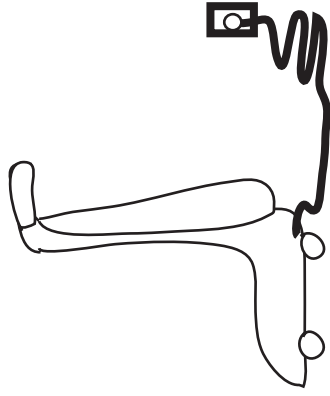
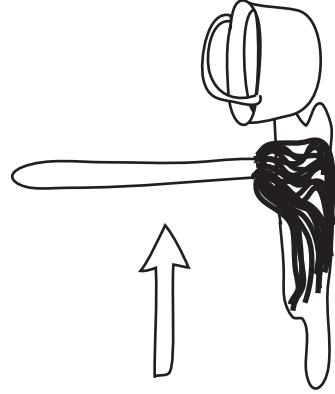
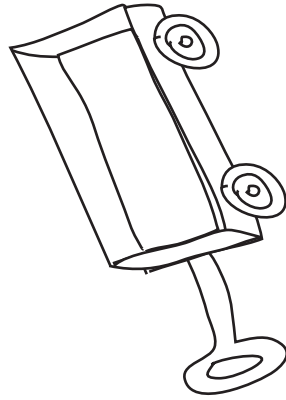
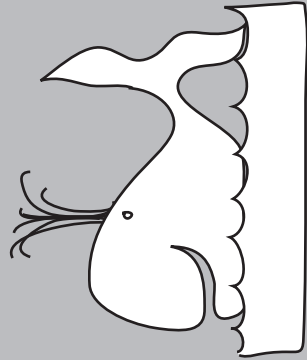
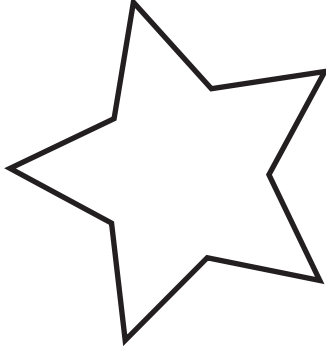
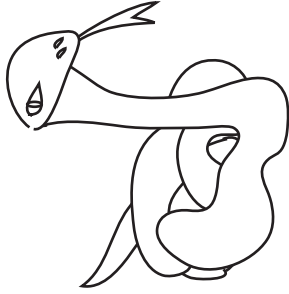
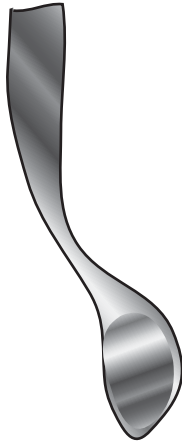
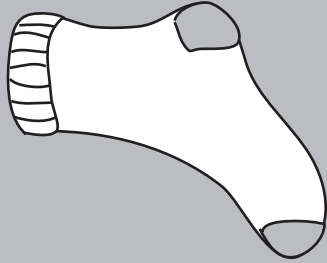
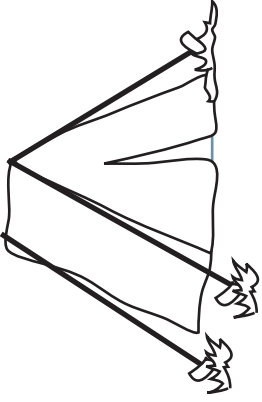
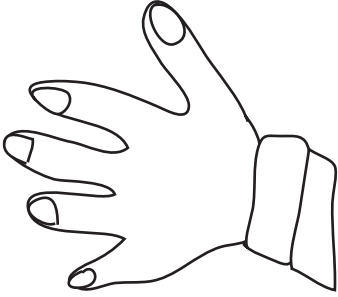
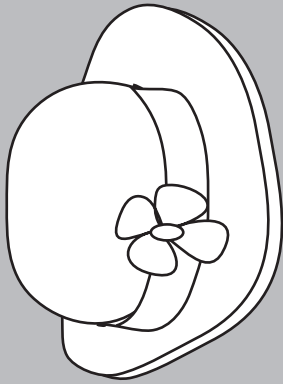

Name _____



Directions:

1. Draw a circle around all of the pictures that begin with the same sound as the picture on the left.
2. Draw an X over the pictures that do not begin with the same sound.

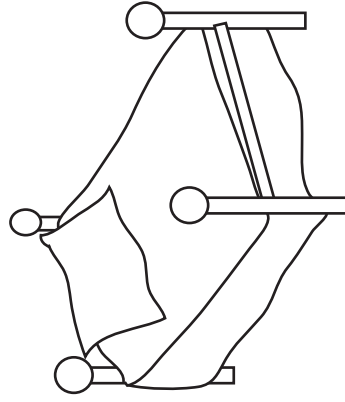
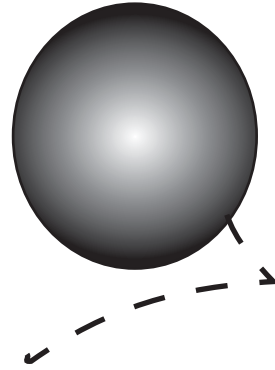
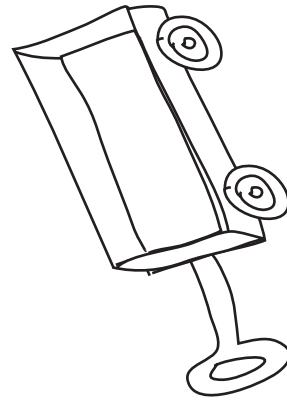
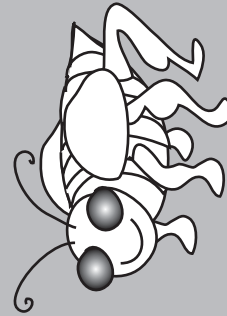
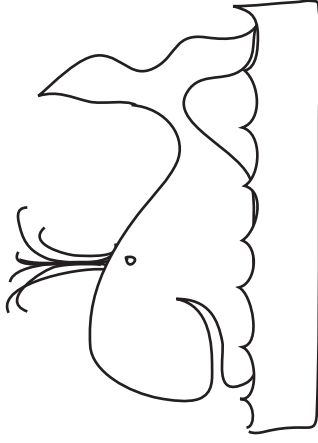
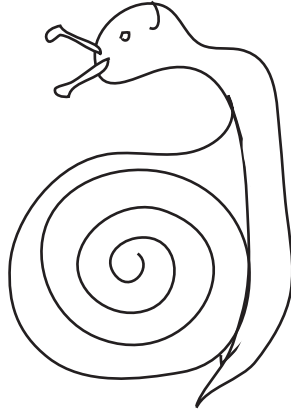
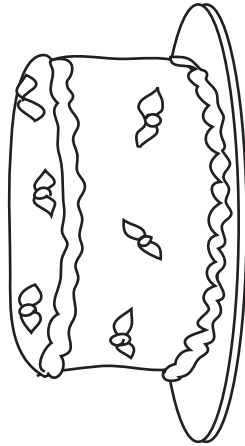
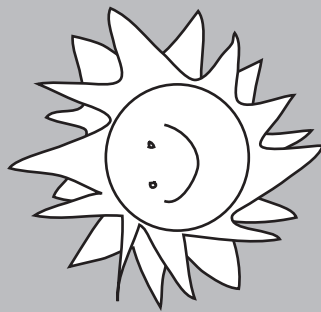
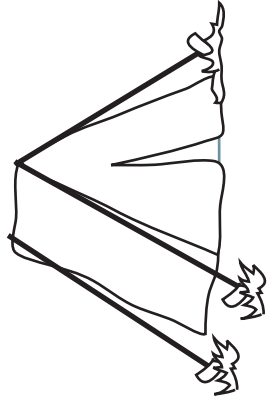
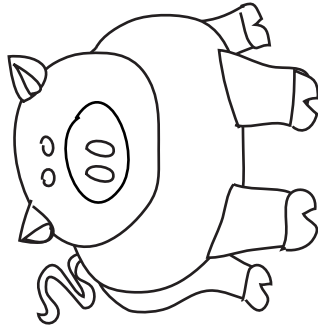
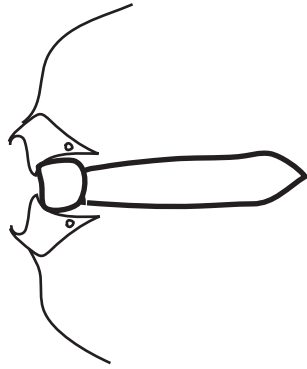
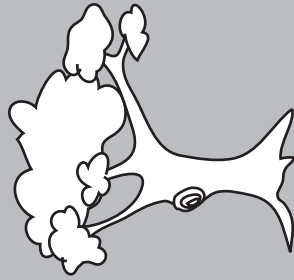

Name _____



Directions:

1. Draw a circle around all of the pictures that begin with the same sound as the picture on the left.
2. Draw an X over the pictures that do not begin with the same sound.

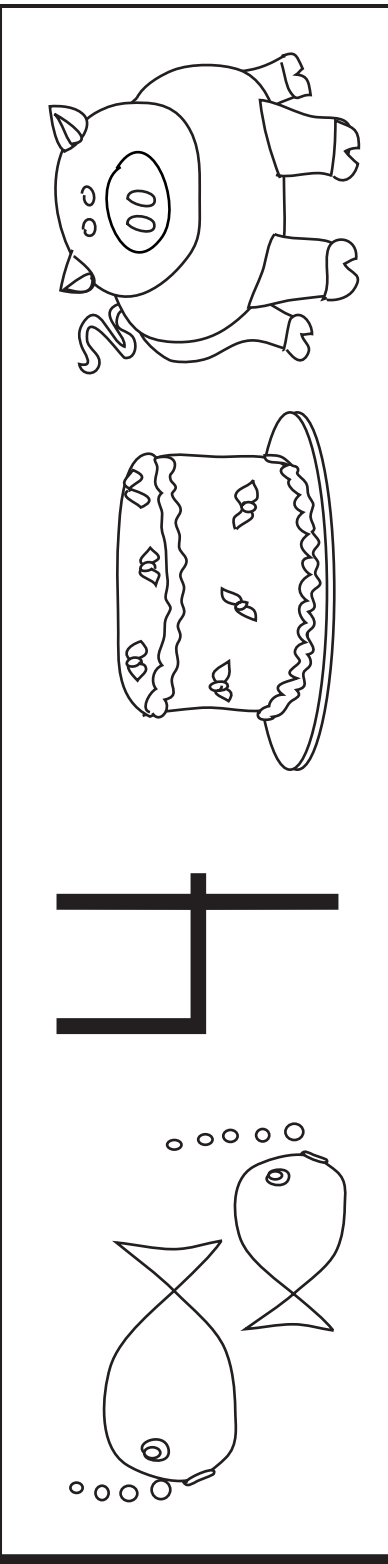
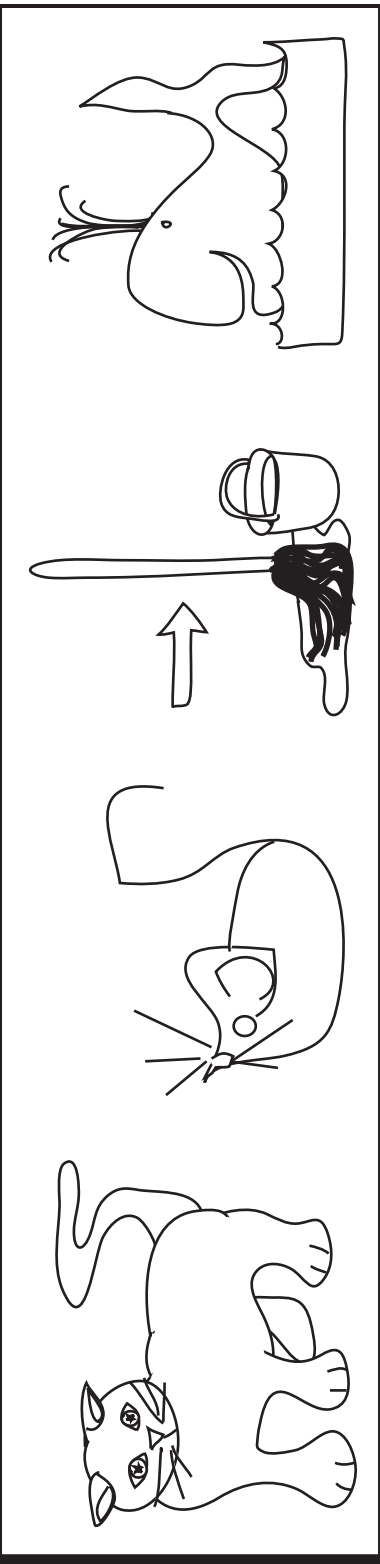
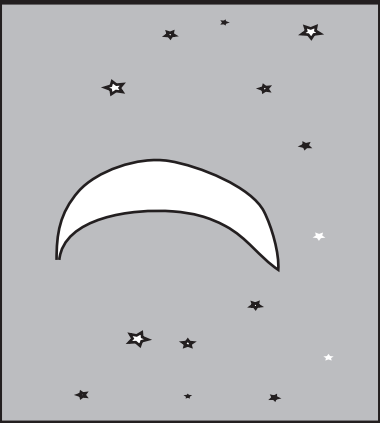
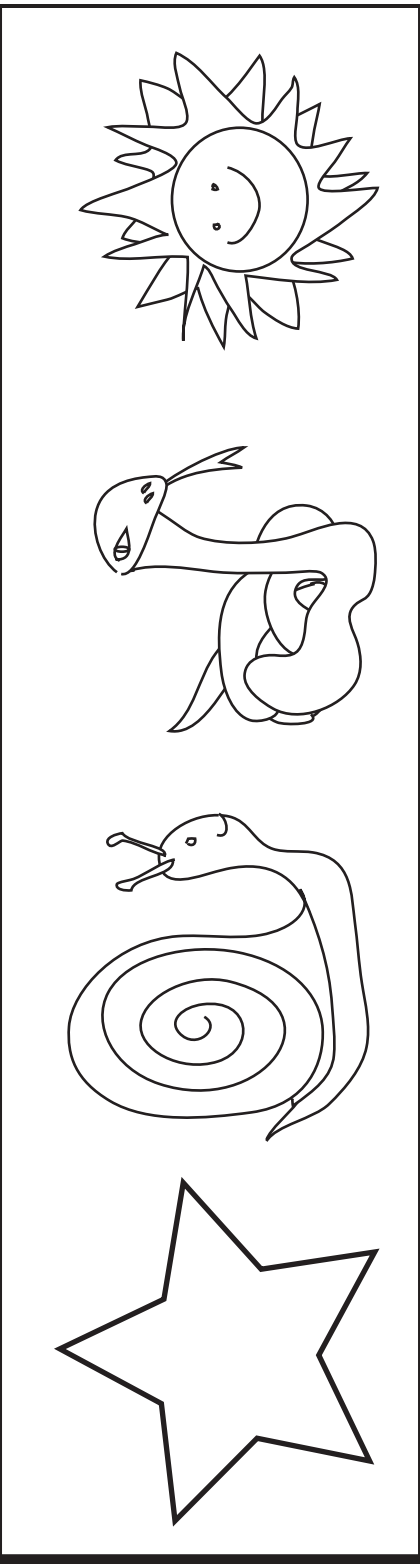

Name _____

Directions:
 1. Draw a circle around all of the pictures that begin with the same sound as the picture on the left.
 2. Draw an X over the pictures that do not begin with the same sound.

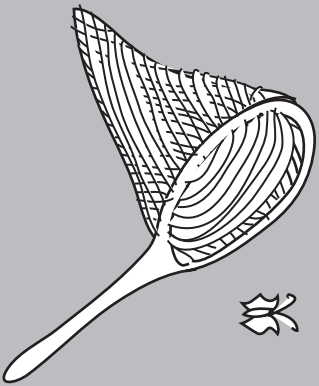

o

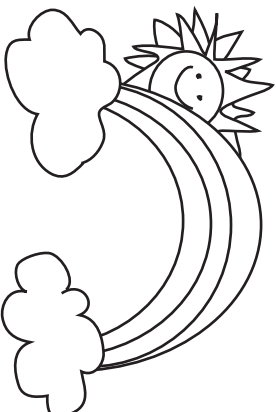
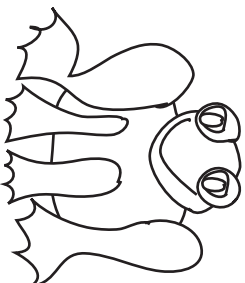
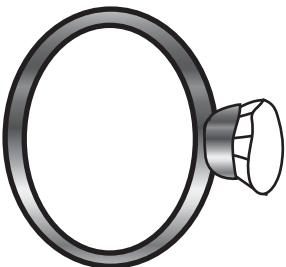
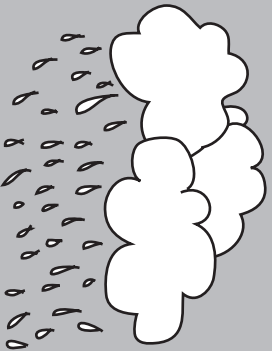
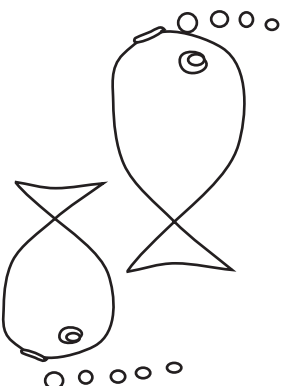
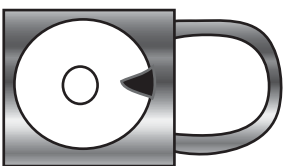
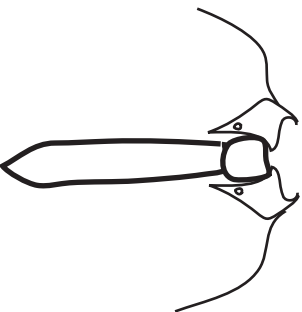
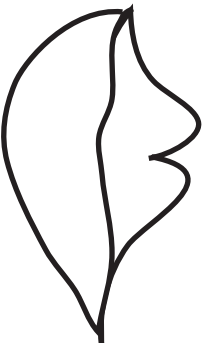
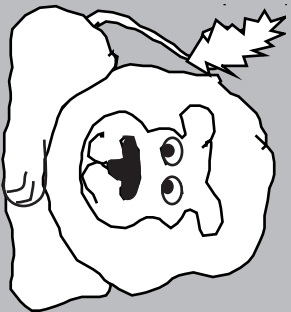
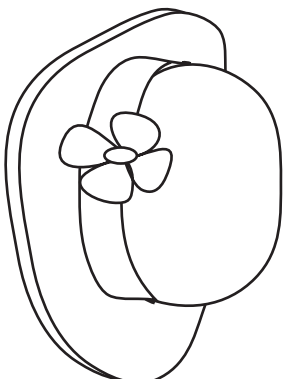
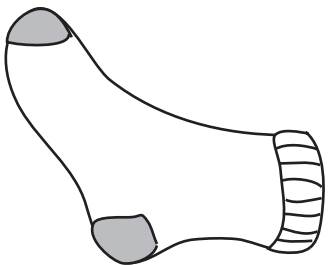

ome